

Producing Foam Sheet using Extrusion



Compiler:

R V Malik-CEO Malik Engineers, Mumbai

Assisted by: Mr. Jitendra Malik (T.E
Mechanical) Rizvi College, Mumbai-400050

Uses of Foam sheet

- Foam sheet produced from Polyethylene plastic is widely used for:
- Thermal insulation. Air-conditioning, etc.
- Shock mitigation and absorption (packing of fragile items)
- Packaging, acoustic insulation.
- Marine floatation, expansion joints in building, etc....
- High density foams are used for sports goods, bottle liners, furniture for weight reduction, etc.

Process for producing LDPE pellet from Ethylene gas

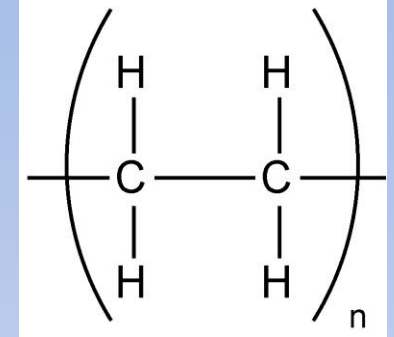
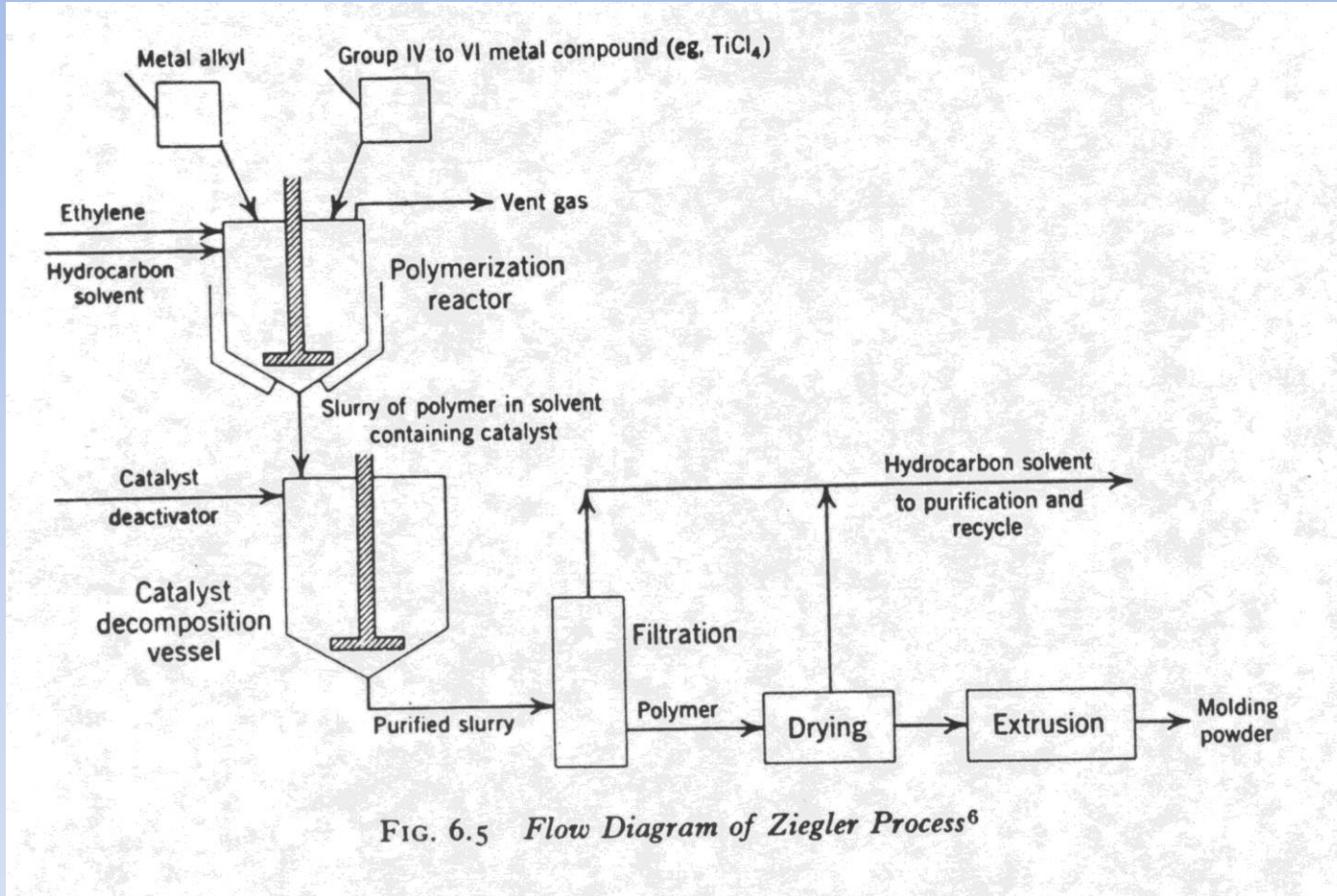

Molecular formula For Polyethylene



Flow path of various raw-materials to produce Low density Polyethylene pellet from Ethylene

Process of production

- Foam sheet is produced using extrusion process from LDPE (Low density polyethylene) plastic which is melted inside a screw extruder.
- The extruder melts the solid plastic material, mixes it with additional ingredients like blowing agent (gas), nucleating agent, etc. to reduce the density of base polymer. (approx. 0.90g/cc or 900 kg/m³ Density reduction causes build up of air cells or pockets which reduces density & overall conduction co-efficient of porous sheet. Inside the Extruder, process temperature is maintained between 100-200 Deg. Centigrade.
- Sheet is formed using suitable tubular die attached to the extruder to produce foam bubble.
- The circular bubble is cooled and slit to get one single layer sheet of required density.
- 2 classes of product- low density sheet has density from 20-50 kg/m³. High density has density from 200-400Kg/m³. Density of base LDPE polymer is 900 Kg/m³.

Foam product examples

Extruded polyethylene foam



Density reduction in foams



A

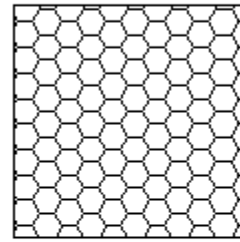

B

Illustrative examples of section through unfoamed polymer shown in Fig. A) and in foamed polymer shown in Fig. B) The voids (cavities) caused by the foaming agent is clearly shown resulting in low density of product compared to unfoamed polymer

Producing low density foam

Extruder uses single or twin screw which rotates inside a stationary barrel.

The heated barrel will melt the polymer and the rotating screw pushes the molten material with additional ingredients like blowing agents, nucleating agent, etc. to lower the density of base polymer to that required approx. $20-50 \text{ Kg/m}^3$.

The blowing agent is usually Liquefied petroleum gas and needs careful handling in production. For high density foams liquid CO_2 can also be used.

Producing high density foams

- High density foam is produced on Extruder using Chemical agents which are mixed inside the Extruder in molten polyethylene along with nucleating agents.
- Special chemical agents release gases when heated and therefore help lower density of base polymer to about 200-500 Kg/m³.
- They are produced using single or twin screw extruder.
- High density foam sheet finds application in sports gear, bottle liners, furniture building, etc.

Picture of Extruders used in Foam production



Single screw Extrusion principle

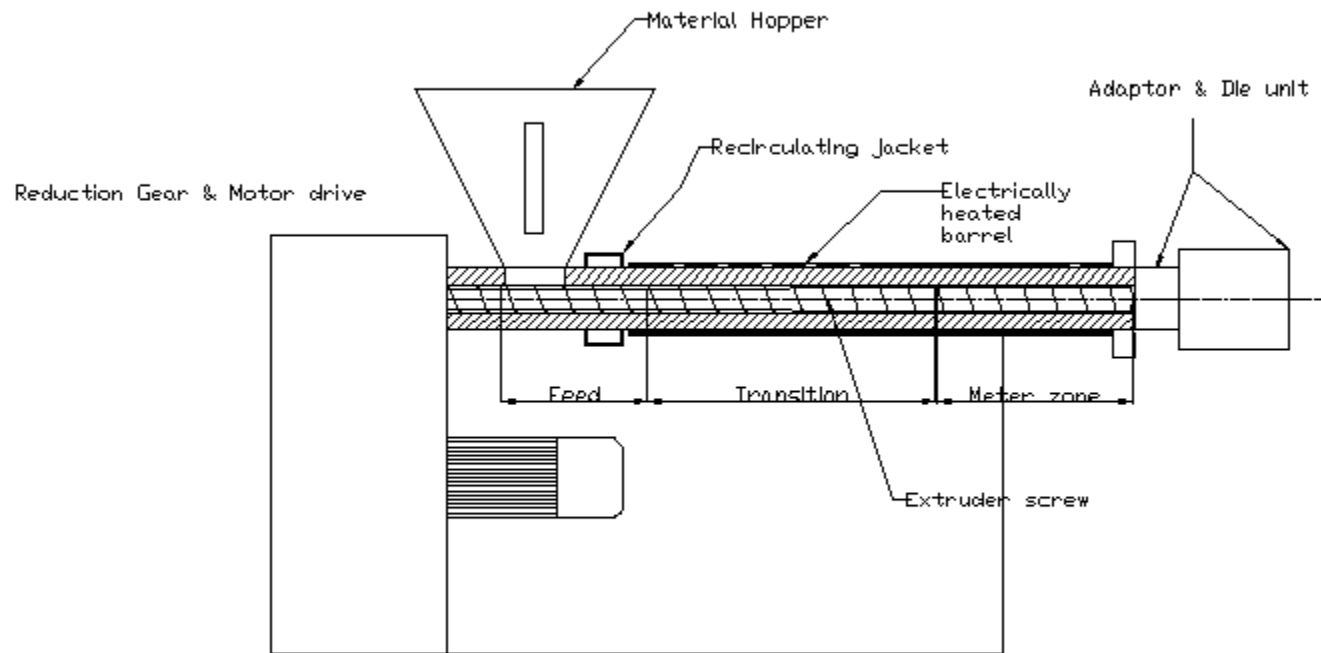

Schematic of conventional single screw Extruder

Single screw Extrusion-Long barrel Extrusion

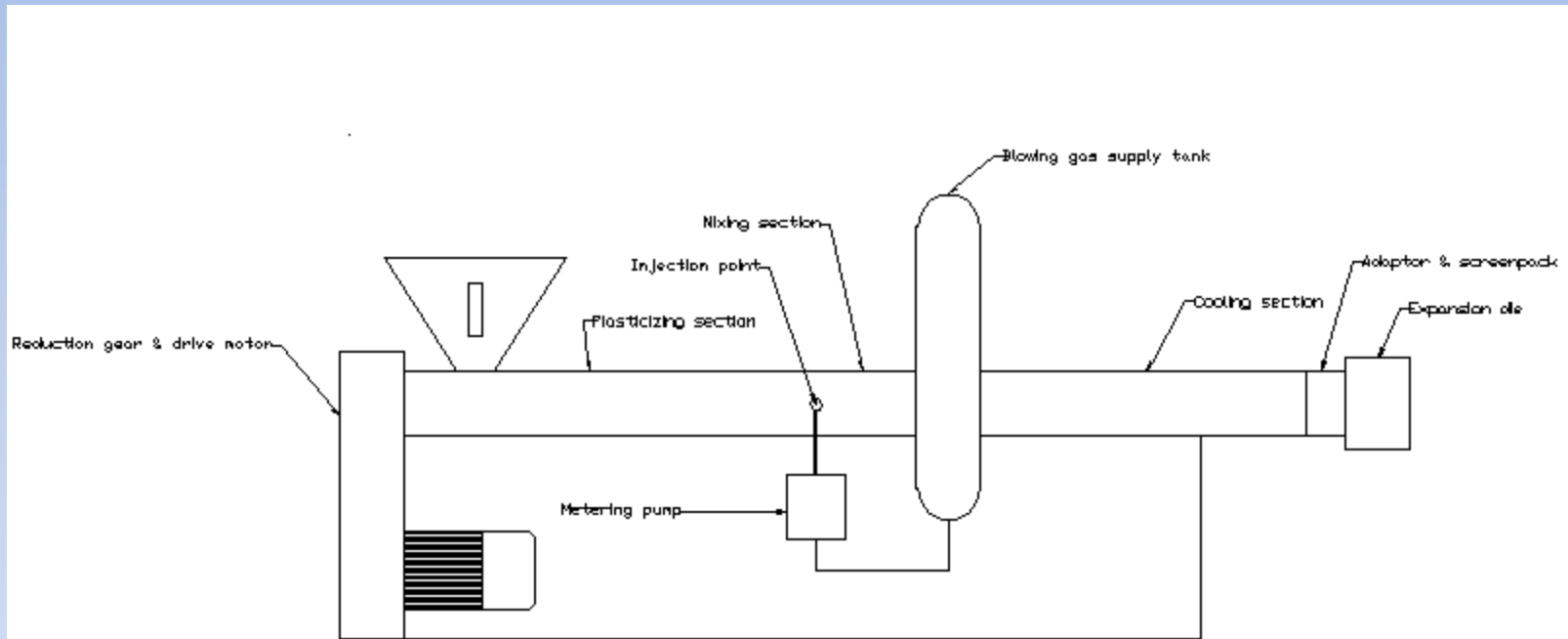

Schematic for Low Density foam (EPE) long barrel extruder

Producing foams- Long barrel extrusion



Single screw Extrusion-Long Barrel Extrusion

- The long barrel Extruders consists of a single screw extruder with a long barrel.
- Half barrel is used for melting the polymer where injection of blow agent (gas) takes place. The remainder length serves to cool the polymer mixed with gas and transport further through the die to produce low density foam.
- Simple to operate and maintain with low capital investment.

Single screw Extrusion-Tandem Extrusion

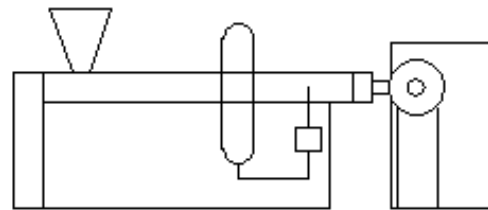
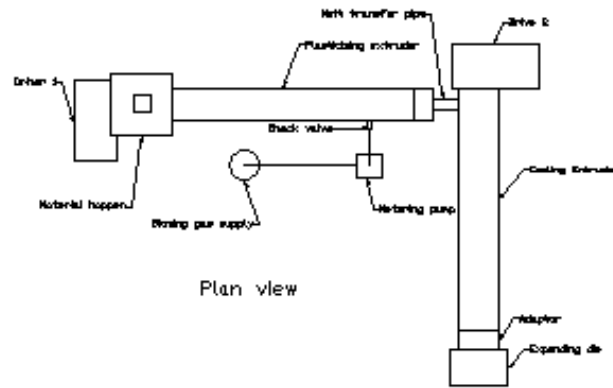

Tandem foam line for producing low density foams using two separate extruders

Single screw Extrusion-Tandem Extrusion



- As it implies, two extruders are used in series- one melts the solid polymer (LDPE).
- Other extruder- in tandem to first mixes the molten polymer with blowing agent injected at junction of two extruders.
- The tandem extruder carries the mix through a die opening at its end to produce low density foam.
- Produces more accurate foam than possible with long barrel extruder.

Producing low density foams-Twin screw Extruder

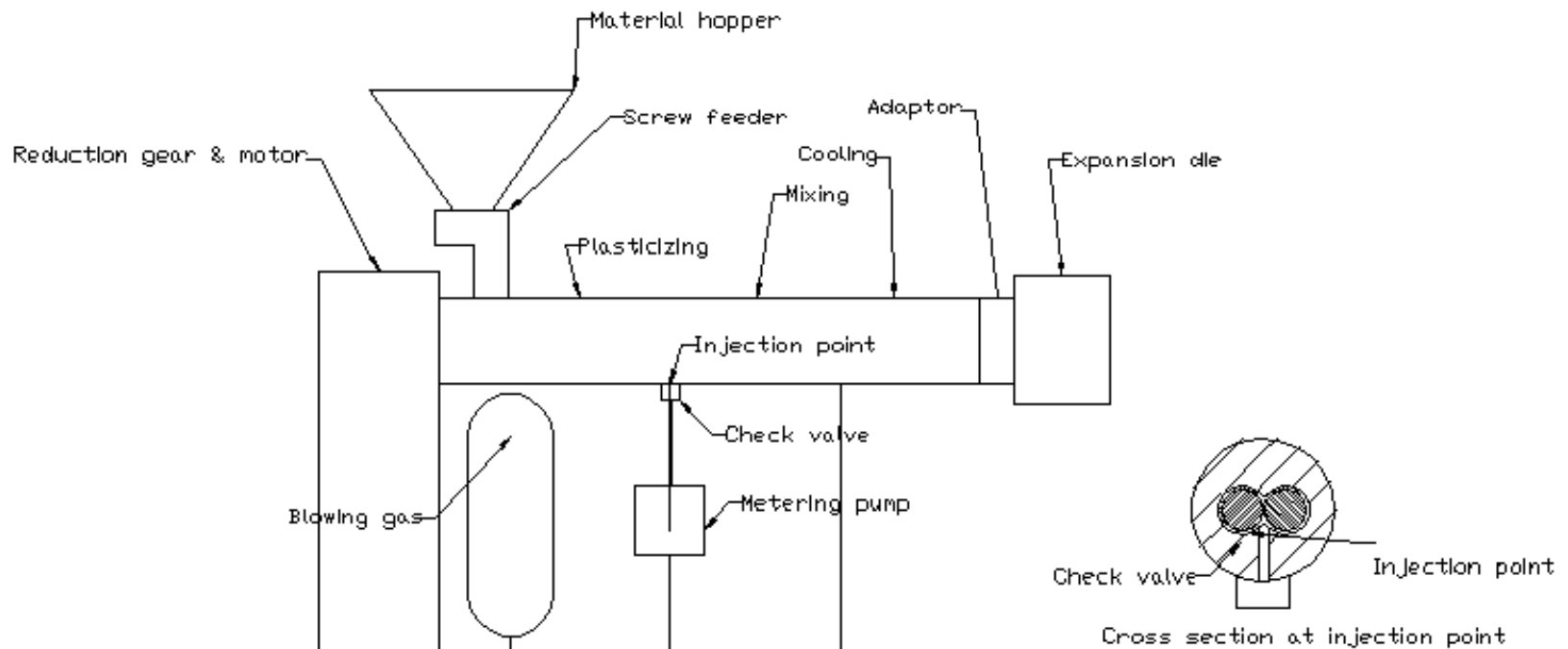

Schematic of Twin screw Extruder for producing Low density foams

Producing low density foams-Twin screw Extruder

- Twin screw extruder uses twin screws to melt and transport the polymer through a stationary barrel of special profile.
- It gives positive transport to materials with maximum output and precision foams.
- Capital cost is more than single screw.
- Complicated to run and maintain.

Conclusion

- Low density foam is produced using LDPE plastic premixed with Chemical Blowing agent to produce high density foam, or injected with Physical Blowing agent during extrusion to produce low density foams.
- Both can be produced using Extruder- single or twin screw.
- Single screw extruder can consist of long barrel or tandem extruders and are easier to run and maintain with low capital cost.
- Twin screw Extruder produces precision foams with more output but complicated to run and maintain.
- Low density foams are used for packaging fragile items, shock absorption, expansion joints, thermal insulation, etc. High density foam is used in sports gear, shoe soles, bottle liners, fancy stickers, etc.

Use of Technology in foam production



Inverter are used to vary the frequency of AC supply which Adjusts speed of induction motors



PID Controllers with feedback sensors are used to Provide accurate temperature and pressure Controls in the process

Use of Technology in foam production

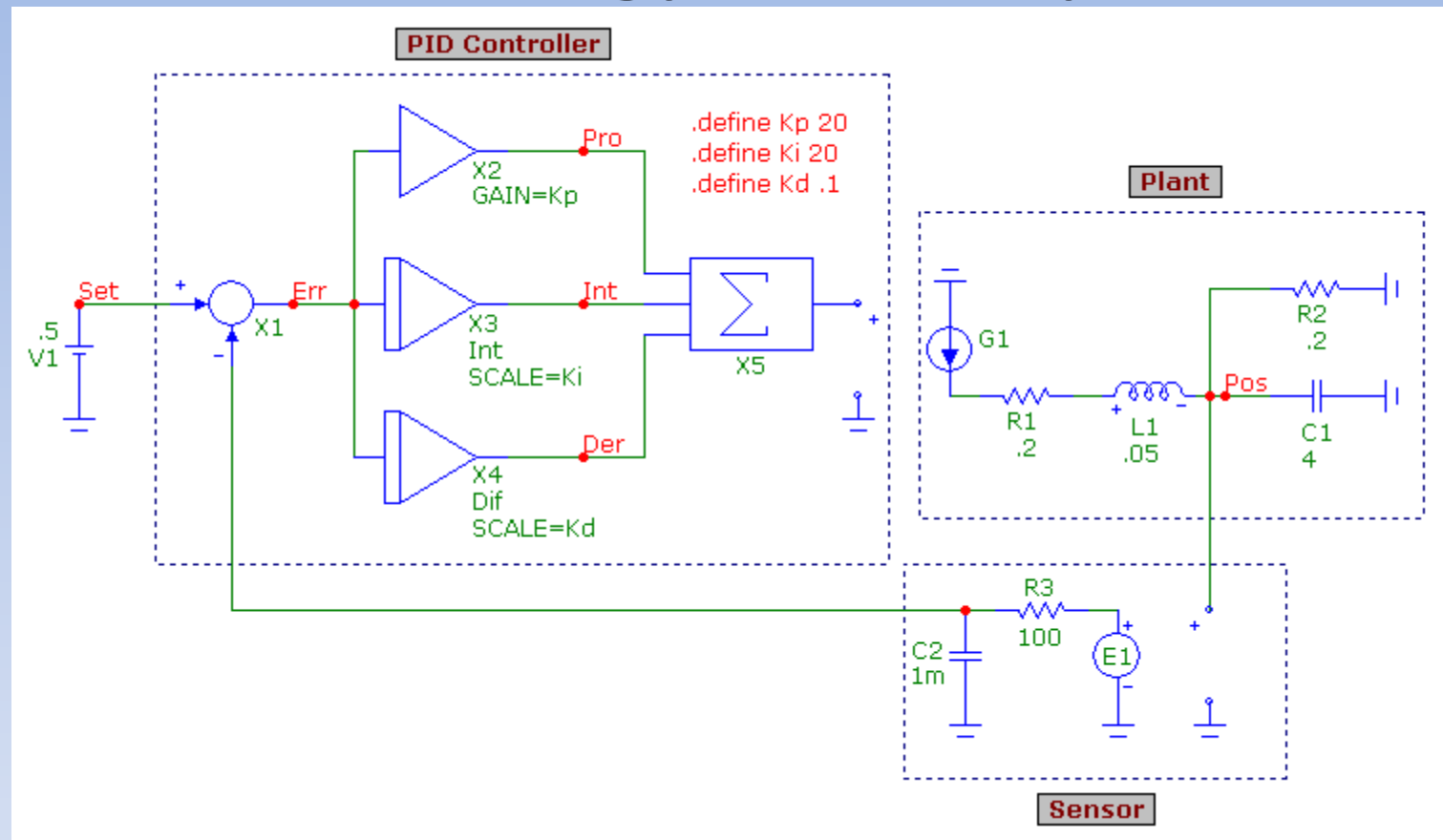

PID Controllers use Proportional, Integral and Derivative Controllers or Op-Amps which Accept feedback from sensors in plant to compare the actual parameter value with the Set or reference value. Any deviation from actual value will result in an error signal Which is used to control the actuator or heater to correct the deviation from the set value of parameter.

Use of Technology in foam production

A PLC has many "input" terminals, through which it interprets "high" and "low" logical states from sensors and switches. It also has many output terminals, through which it outputs "high" and "low" signals to power lights, solenoids, contactors, small motors, and other devices lending themselves to on/off control. In an effort to make PLCs easy to program, their programming language was designed to resemble ladder logic diagrams. Thus, an industrial electrician or electrical engineer accustomed to reading ladder logic schematics would feel comfortable programming a PLC to perform the same control functions.

Use of Technology in foam production

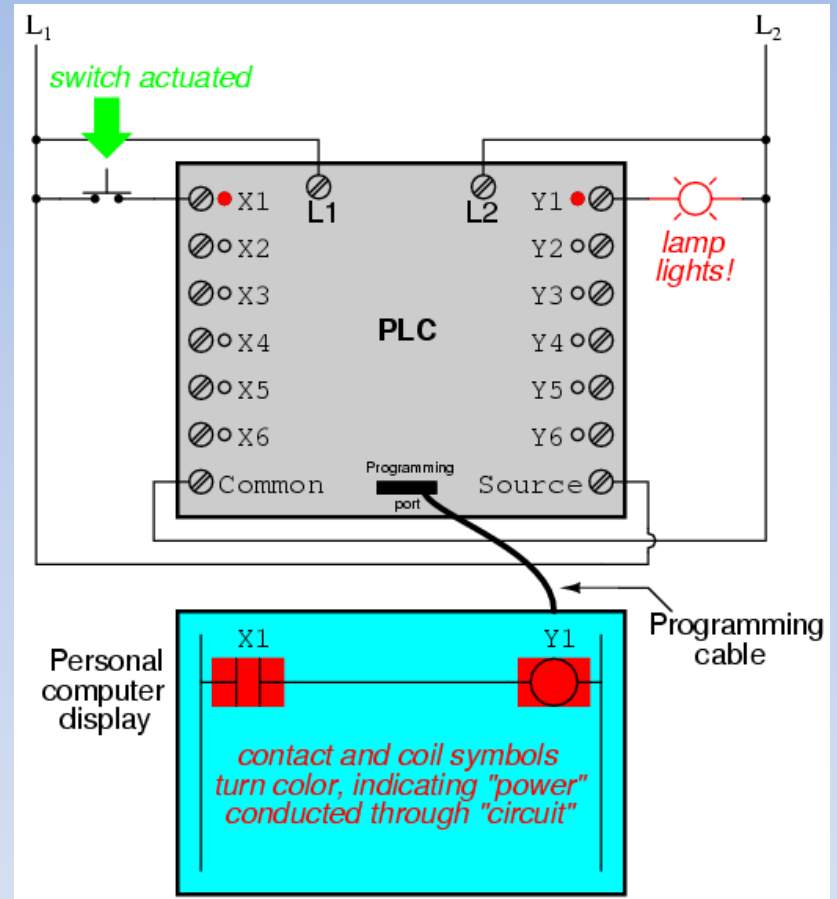

PLCs are used in Extrusion line for automatic control of production

Transducers used in Foam production



Temperature &
Pressure Transducers
(Tempt. To voltage and
Pressure-Current Transducer)

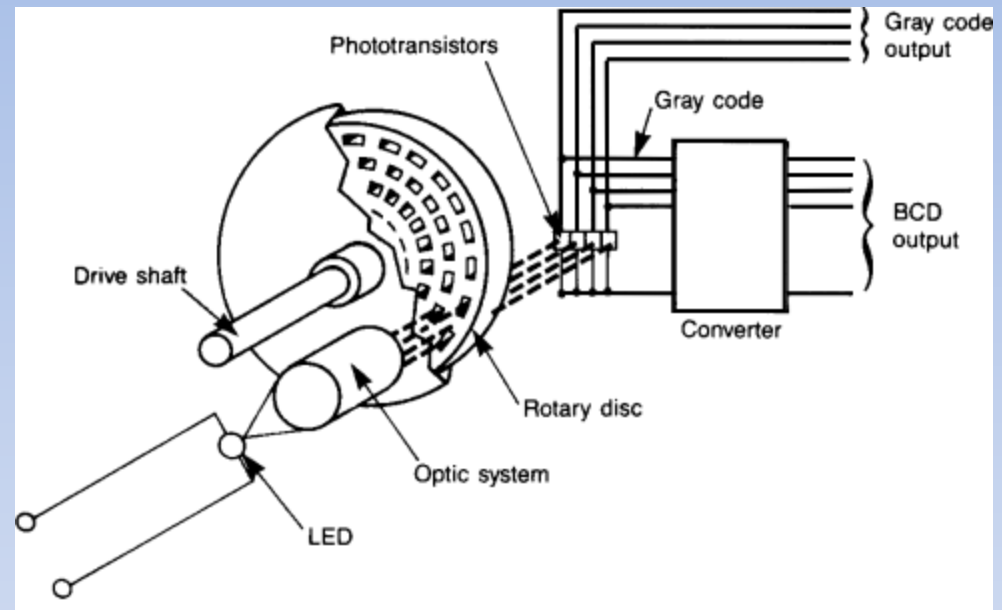

Optical Encoder Transducer for feedback of motor speed

Transducers used in Foam production

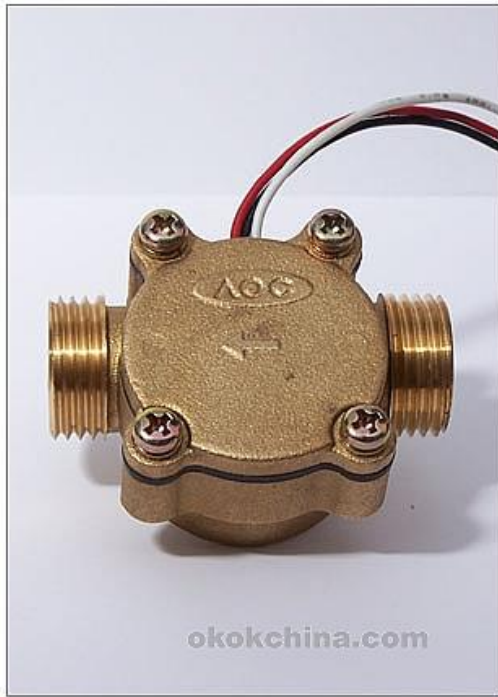

Gas flow sensor for Blowing agent generates
Output current proportional to flow

- Thank you!
- Contact: info@malikengg.com